

HW 1000 | Wedge

Specifications		
article number		100.562.009
model		HW 1000
max. working pressure	psi	10443
short description		Wedge
max. spreading force	lbf	2248
tonnage	lb	2205.0
min. insertion space	in	0.6
lifting stroke	in	3.5
required oil content (effective)	oz	0.3
return type		spring
weight, ready for use	lb	4.6

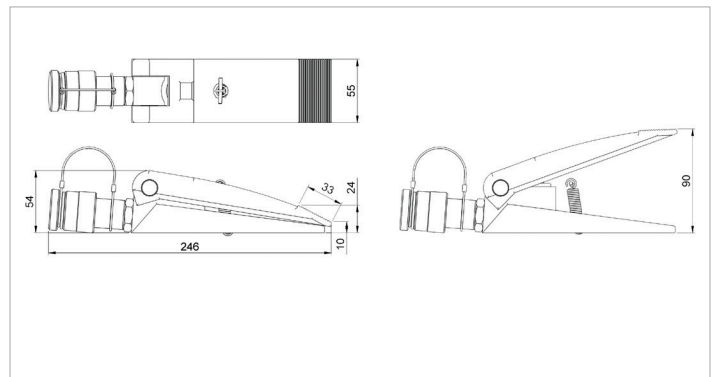

holmatro.com

© Holmatro 2020-06-01

While the greatest care has been devoted to the content, it is possible that the information in this printed matter is incorrect or incomplete. Holmatro B.V. and its affiliated companies (hereafter: Holmatro) cannot be held liable in any way for the consequences of activities undertaken on the basis of this printed matter. Values can vary within the manufacturer measurements. If you have any doubts about the correctness or completeness of the information, you shall contact Holmatro (T +31 (0)162-751480). Nothing from this printed matter can be copied and/or made public in any way without the explicit authorisation of Holmatro.