

Technical specification sheet

HLC 50 H 5 | Locknut Cylinder

Specifications		
article number		100.122.123
short description		Locknut Cylinder
model		HLC 50 H 5
max. working pressure	psi	10443
tonnage	lb	132277.0
stroke	in	2
closed height	in	8.2
max. side-load resistance	%	10
capacity	lbf	129940
effective pressure area (press)	sq. in.	12.4
effective pressure area (retract)	sq. in.	2.6
required oil content (effective)	oz	10.8
required oil content (press)	oz	13.6
required oil content (retract)	oz	2.8
connection		A 118
cylinder type		lock nut
acting type		double
return type		hydraulic
material		steel
weight, ready for use	lb	43.0
ASME		B30.1

Technical drawing dimensions		
dimension A	in	8.2
dimension B	in	5.1
dimension C1	in	2.8
dimension C2	in	2.2
dimension D	in	3
dimension E	in	1.5
dimension F	in	6.7
dimension P	in	2.3
dimension T	in	4.5
dimension U	in	2.1
angle A1	°	23
angle A2	°	90

Standard supplied with	
• High flow female coupler A118	
• Tilting saddle	

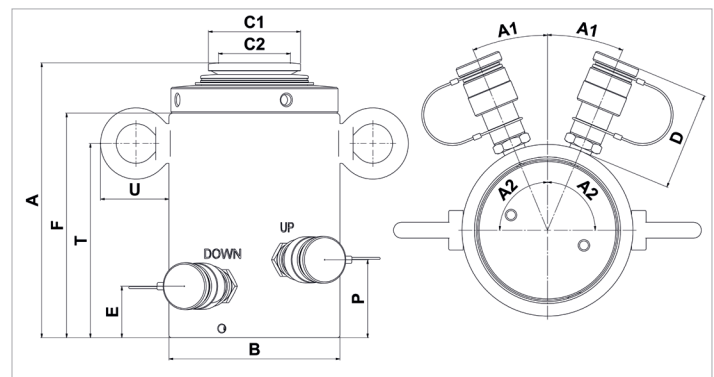

holmatro.com

© Holmatro 2023-12-06

While the greatest care has been devoted to the content, it is possible that the information in this printed matter is incorrect or incomplete. Holmatro B.V. and its affiliated companies (hereafter: Holmatro) cannot be held liable in any way for the consequences of activities undertaken on the basis of this printed matter. Values can vary within the manufacturer measurements. If you have any doubts about the correctness or completeness of the information, you shall contact Holmatro (T +31 (0)162-751480). Nothing from this printed matter can be copied and/or made public in any way without the explicit authorisation of Holmatro.