

Technical specification sheet

HGC 75 S 15 | Multi Purpose Cylinder

Specifications		
article number		100.112.255
short description		Multi Purpose Cylinder
model		HGC 75 S 15
max. working pressure	bar/Mpa	720 / 72
tonnage	t	75
stroke	mm	150
closed height	mm	285
capacity	kN/t	748 / 76.3
effective pressure area	cm ²	103.9
required oil content (effective)	cc	1558
connection		A 118
cylinder type		multi purpose
acting type		single
return type		spring
material		steel
weight, ready for use	kg	30.9
ASME		B30.1

Technical drawing dimensions		
dimension A	mm	285
dimension B	mm	147
dimension C1	mm	97
dimension C2	mm	62
dimension D	mm	80
dimension E	mm	25
dimension F	mm	279
dimension G	mm	8
dimension J	threadsize	5 $\frac{3}{4}$ "-12-UN
dimension K	mm	57
dimension L	mm	75
dimension M	mm	10
dimension N	mm	115
dimension O	threadsize	M12x18 (2x)
dimension T	mm	165
dimension U	mm	54
angle A1	°	90

Standard supplied with
<ul style="list-style-type: none"> • Collar thread and base mounting holes • Internal plunger thread on all models to 50 tons • High flow female coupler A118 • Flat saddle

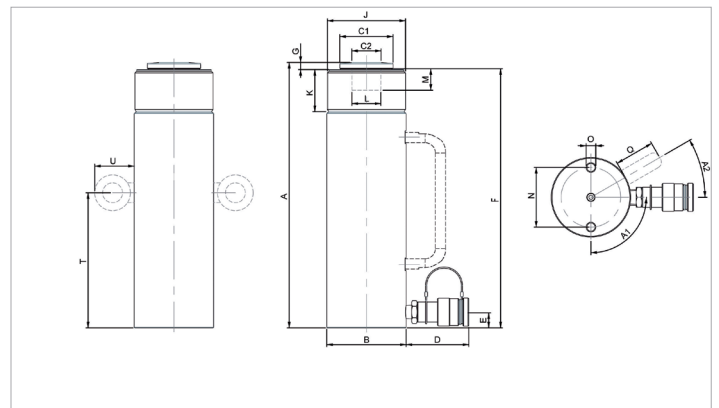

holmatro.com

© Holmatro 2023-11-30

While the greatest care has been devoted to the content, it is possible that the information in this printed matter is incorrect or incomplete. Holmatro B.V. and its affiliated companies (hereafter: Holmatro) cannot be held liable in any way for the consequences of activities undertaken on the basis of this printed matter. Values can vary within the manufacturer measurements. If you have any doubts about the correctness or completeness of the information, you shall contact Holmatro (T +31 (0)162-751480). Nothing from this printed matter can be copied and/or made public in any way without the explicit authorisation of Holmatro.