

Technical specification sheet

HAC 30 S 10 | Aluminium Cylinder

Specifications		
article number		100.112.268
short description		Aluminium Cylinder
model		HAC 30 S 10
max. working pressure	psi	10443
tonnage	lb	66139.0
stroke	in	3.9
closed height	in	9.1
capacity	lbf	71512
effective pressure area	sq. in.	6.9
required oil content (effective)	oz	14.9
connection		A 118
cylinder type		standard
acting type		single
return type		spring
material		aluminium
weight, ready for use	lb	13.0
ASME		B30.1

Technical drawing dimensions		
dimension A	in	9.1
dimension B	in	4.2
dimension C	in	2.6
dimension D	in	3
dimension E	in	1.1
dimension F	in	8.9
dimension G	in	0.3
dimension Q	in	1.7
angle A2	°	40
I type		[I2]

- Standard supplied with**
- High flow female coupler A118
 - Flat saddle
 - Larger cylinders are equipped with handles for easy carrying and positioning

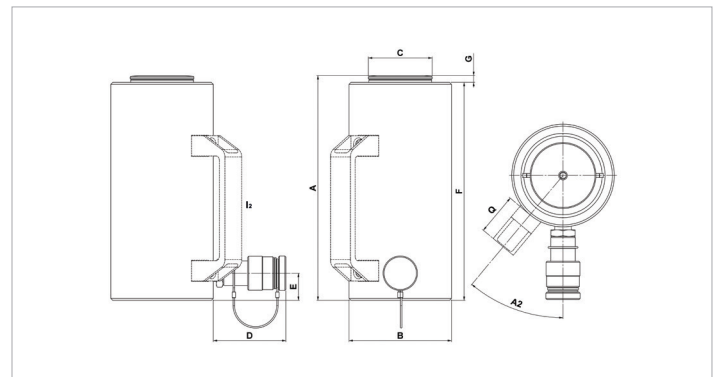

holmatro.com

© Holmatro 2023-11-29

While the greatest care has been devoted to the content, it is possible that the information in this printed matter is incorrect or incomplete. Holmatro B.V. and its affiliated companies (hereafter: Holmatro) cannot be held liable in any way for the consequences of activities undertaken on the basis of this printed matter. Values can vary within the manufacturer measurements. If you have any doubts about the correctness or completeness of the information, you shall contact Holmatro (T +31 (0)162-751480). Nothing from this printed matter can be copied and/or made public in any way without the explicit authorisation of Holmatro.