

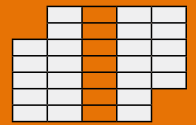

INDUSTRIAL CUTTERS - ICU / BCU 5, 10 & 20



DAILY MAINTENANCE | DAGELIJKS ONDERHOUD

The daily preventive maintenance will take approximately 1-2 minutes and will ensure that your cutter will stay in optimal condition.
 Het preventieve dagelijks onderhoud van 1-2 minuten zorgt ervoor dat de schaar in optimale conditie blijft functioneren.



1  Check couplers for dirt and damage (only for ICU).
 Controleer koppelingen op vuil en beschadigingen (alleen voor ICU).



2  Check dust caps for dirt and damage (only for ICU).
 Controleer stofkap op vuil en beschadiging (alleen voor ICU).



3  Check hoses for damage and leaks (only for ICU).
 Controleer slangen op schade en lekkage (alleen voor ICU).



4  START position
 START positie

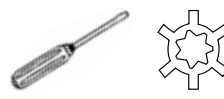
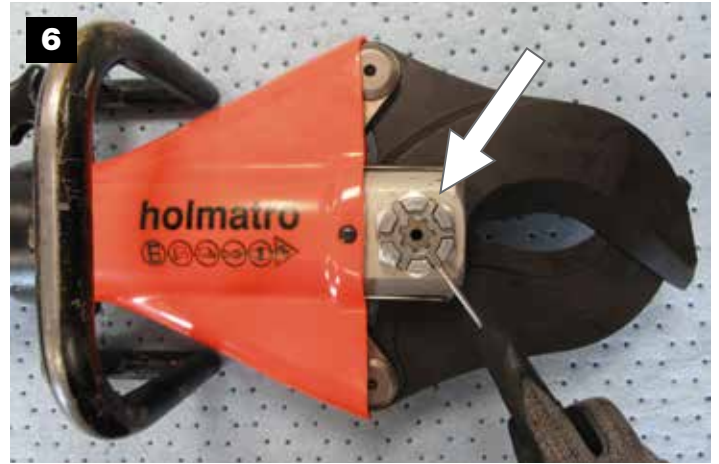

ICU 5: **36mm**
ICU 10 / 20: **41mm**

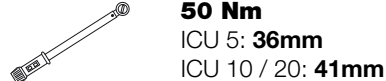

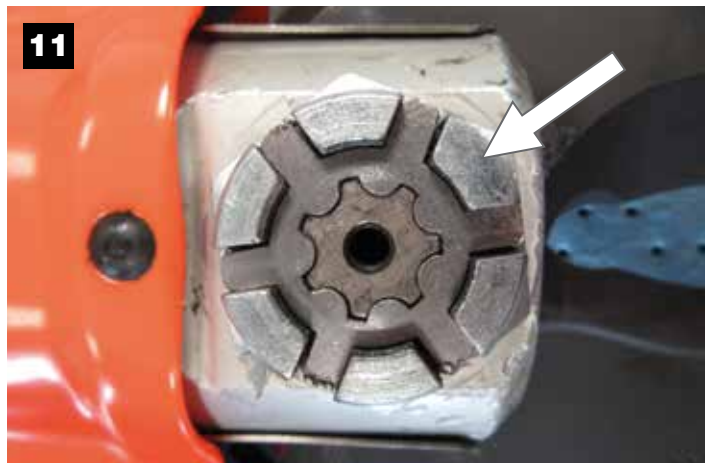

 **!** fits in 1 way
 past op 1 manier





 4mm

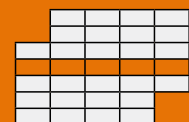

WEEKLY MAINTENANCE | WEKELIJKS ONDERHOUD

Binnen enkele minuten is de schaar weer klaar voor gebruik. Door structureel deze handelingen uit te voeren verlengt u de levensduur van de schaar.
 With a couple minutes the cutter is ready to use. You will extend the lifetime of the cutter by completing this important maintenance.



 Check couplers for dirt and damage (only for ICU).
 Controleer koppelingen op vuil en beschadigingen (alleen voor ICU).



 Check dust caps for dirt and damage (only for ICU).
 Controleer stofkap op vuil en beschadiging (alleen voor ICU).



3

Check hoses for damage and leaks (only for ICU).
Controleer slangen op schade en lekkage (alleen voor ICU).



4

START positie
START position



5

both sides
beide zijden

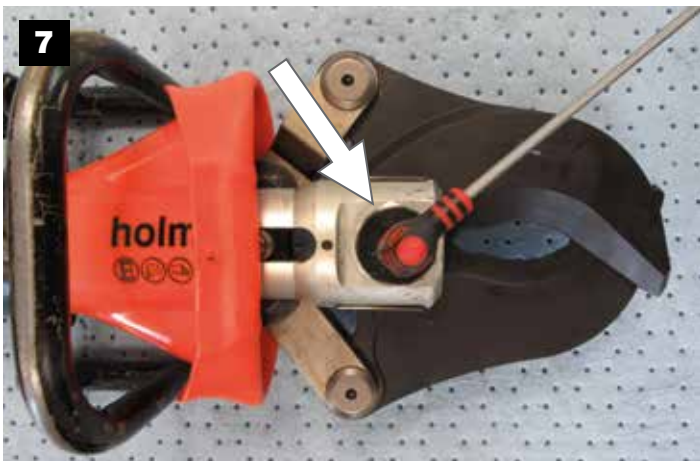
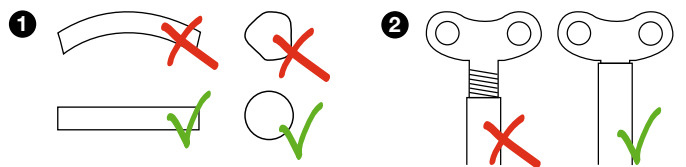

7

4mm



8

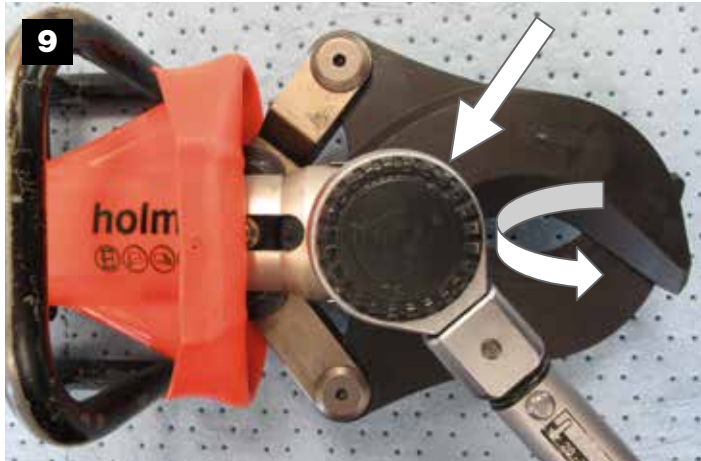

ICU 5: **36mm**
ICU 10 / 20: **41mm**



both sides
beide zijden

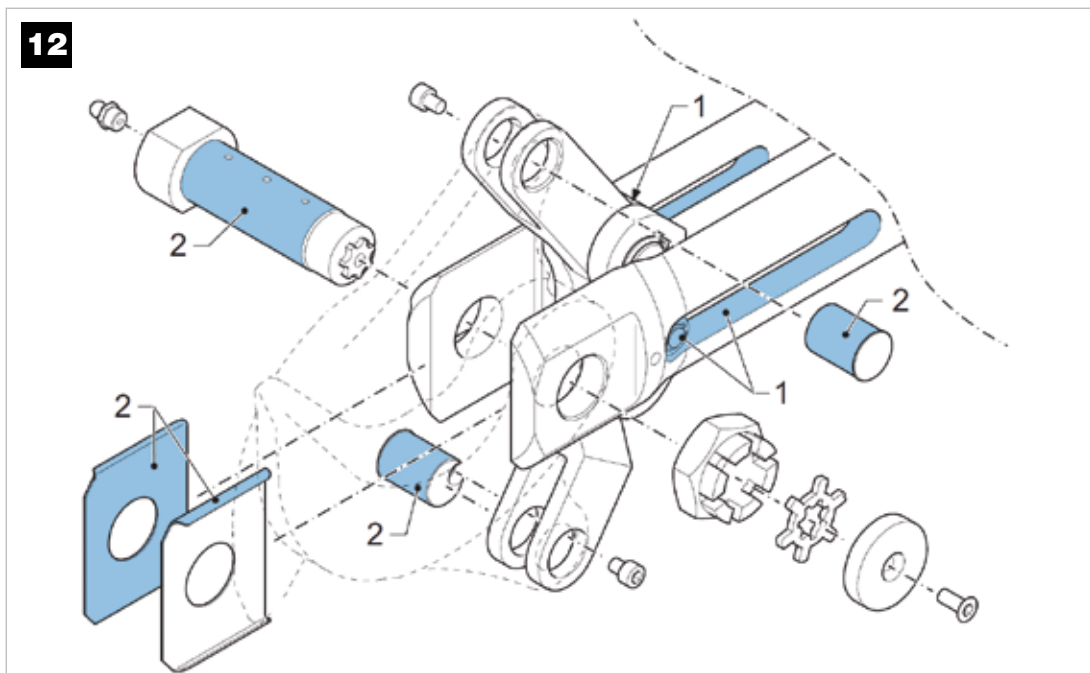
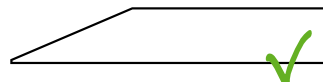
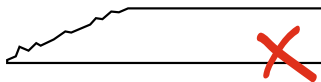

all parts
alle onderdelen
(Motip)



(Sir John)



(Molycote)

