

INDUSTRIAL CUTTERS - ICU / BCU 40

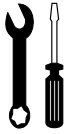

DAILY MAINTENANCE | DAGELIJKS ONDERHOUD

The daily preventive maintenance will take approximately 1-2 minutes and will ensure that your cutter will stay in optimal condition.
 Het preventieve dagelijks onderhoud van 1-2 minuten zorgt ervoor dat de schaar in optimale conditie blijft functioneren.

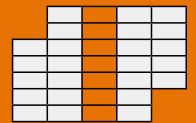

1

Check couplers for dirt and damage (only for ICU).
 Controleer koppelingen op vuil en beschadigingen (alleen voor ICU).



2

Check dust caps for dirt and damage (only for ICU).
 Controleer stofkap op vuil en beschadiging (alleen voor ICU).



3

Check hoses for damage and leaks (only for ICU).
 Controleer slangen op schade en lekkage (alleen voor ICU).



4

START position
 START positie

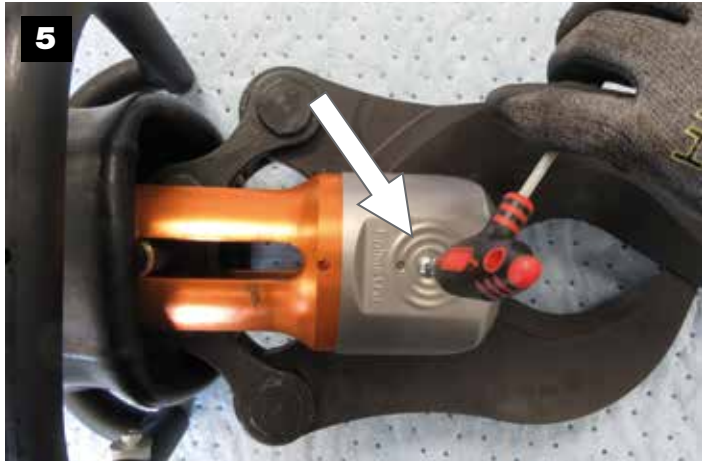

5
4 mm



6



7



8
41 mm



9
50 Nm (41mm)

Check torque and spray all hinge points with Teflon spray.
Controleer het moment en spuit alle scharnierpunten in met Teflon spray.



10

! fits in 1 way
! past op 1 manier



 **!** fits in 1 way
past op 1 manier

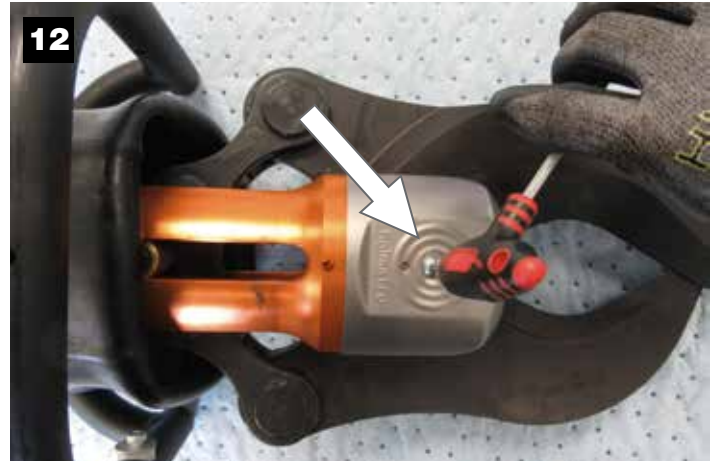

 **4 mm**



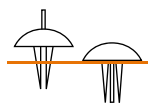

WEEKLY MAINTENANCE | WEKELIJKS ONDERHOUD

Binnen enkele minuten is de schaar weer klaar voor gebruik. Door structureel deze handelingen uit te voeren verlengt u de levensduur van de schaar.
 With a couple minutes the cutter is ready to use. You will extend the lifetime of the cutter by completing this important maintenance.

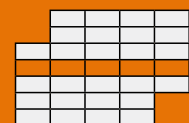

1 Check couplers for dirt and damage (only for ICU).
 Controleer koppelingen op vuil en beschadigingen (alleen voor ICU).



2 Check dust caps for dirt and damage (only for ICU).
 Controleer stofkap op vuil en beschadiging (alleen voor ICU).



3 Check hoses for damage and leaks (only for ICU).
 Controleer slangen op schade en lekkage (alleen voor ICU).



4 START position
 START positie



5
both sides
beide zijden

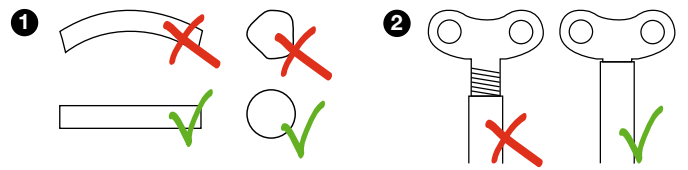
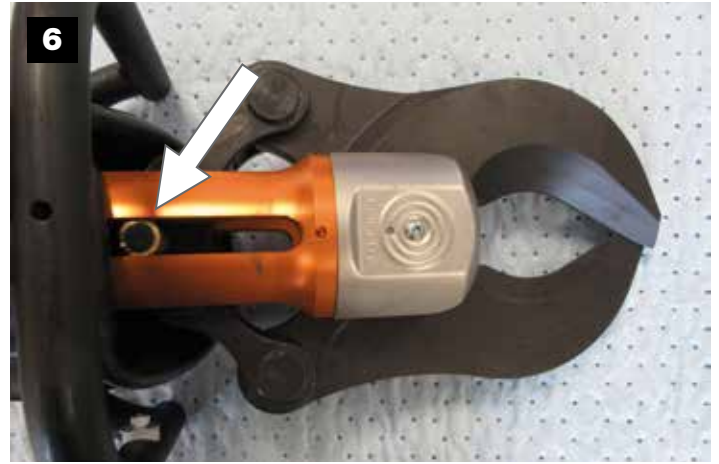

7
4 mm





10
41 mm



both sides
beide zijden

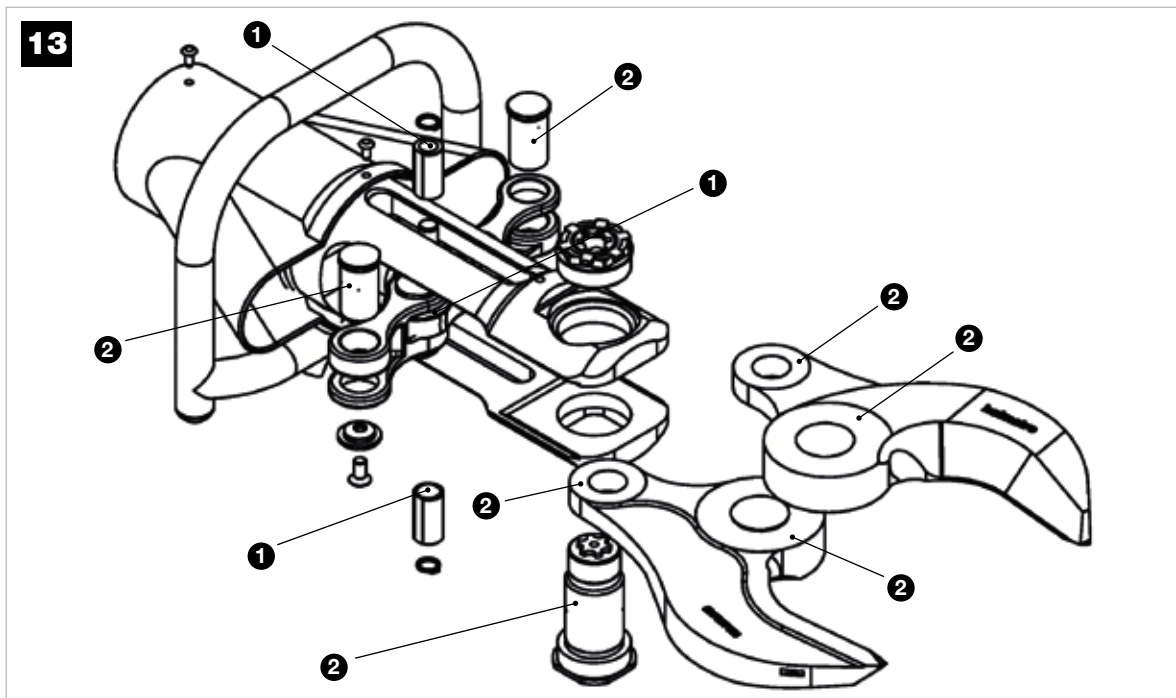
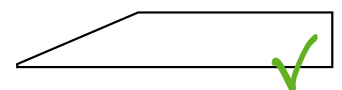
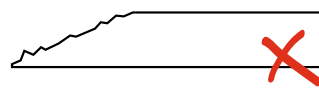

all parts
alle onderdelen
(Motip)



(Sir John)



(Molycote)



