

Technical specification sheet

HBP05S02 | APEIRON Holmatro Battery Pump

Specifications		
article number		101.003.400
model		HBP05S02
short description		APEIRON Holmatro Battery Pump
max. working pressure	bar/Mpa	720 / 72
battery included		Yes, 2 pcs
connectivity, mobile app		Bluetooth
number of stages		stepless
high pressure output / min	cc	500
low pressure output / min	cc	3100
capacity oil tank	cc	2500
capacity oil tank (effective)	cc	2000
protection rate		IP44
sound emission @ 1m/3.25ft	dB(A)	75
sound emission @ 4m/13ft	dB(A)	61
operator type		battery
acting type		single
couplers		yes, 1 pcs A119 male
hydraulic oil type		ISO-L HV VG 36
engine		28 VDC - 0.8 kW
weight, ready for use	kg	13.3
dimensions (LxWxH)	mm	520 x 225 x 260
temperature range	°C	-20 +55
dimensions (AxBxC)	mm	520 x 260 x 225
weight (excl. battery)	kg	11.7

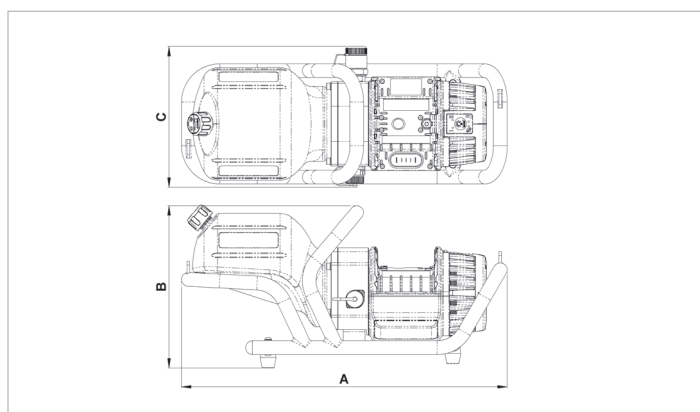

Standard supplied with	
• 2 Batteries	
• Hand pendant control, 3m length cord	
• Couplers that suit the application: plug and play	

Required Accessories	
Battery Charger PBCH1 (AC-EU)	101.003.242
Battery Charger PBCH5 (AC-UK)	101.003.243
Battery Charger PBCH2 (AC-US)	101.003.244



holmatro.com

© Holmatro 2026-06-25

While the greatest care has been devoted to the content, it is possible that the information in this printed matter is incorrect or incomplete. Holmatro B.V. and its affiliated companies (hereafter: Holmatro) cannot be held liable in any way for the consequences of activities undertaken on the basis of this printed matter. Values can vary within the manufacturer measurements. If you have any doubts about the correctness or completeness of the information, you shall contact Holmatro (T +31 (0)162-751480). Nothing from this printed matter can be copied and/or made public in any way without the explicit authorisation of Holmatro.