

Technical specification sheet

12 S 12 Q | Vari pump

Specifications			
article number			101.003.037
model			12 S 12 Q
max. working pressure	psi		10443
short description			Vari pump
capacity oil tank (effective)	oz		405.8
number of outputs			1
number of stages			1
first stage output / min.	oz		37.2
first stage pressure range	psi		0 - 10443
operator type			electric motor
engine			110 VAC - 1.1 kW - 50 Hz - 1 Ph
speed	rpm		3600
weight, ready for use	lb		101.4
dimensions (AxBxC)	in		15.7 x 15.9 x 23.3

Technical drawing dimensions			
dimension A	in		15.7
dimension B	in		15.9
dimension C	in		23.3

Required Accessories			
Control Valve - Single Acting - M 311			100.181.311
Control Valve - Double Acting - M 322			100.181.322

Accessories			
Single-/Double Acting Valve (SADA) M 304			100.172.051
Control Valve - Double Acting - M 323 (Deadmans Function)			100.181.323
Remote Control Valve + Oil Filter - Double Acting - M 326			100.182.321
Pressure Control Valve M 303			100.181.303

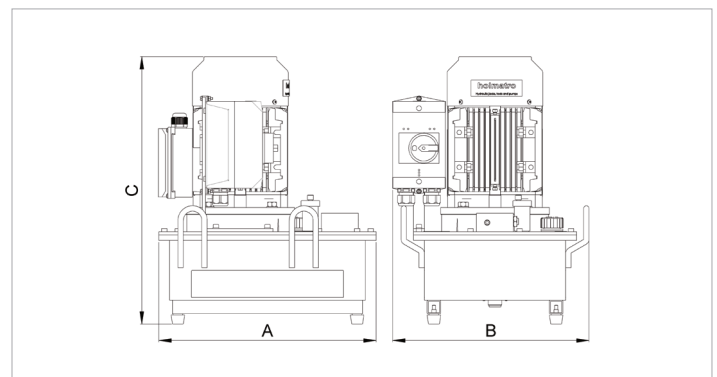

holmatro.com

© Holmatro 2025-09-28

While the greatest care has been devoted to the content, it is possible that the information in this printed matter is incorrect or incomplete. Holmatro B.V. and its affiliated companies (hereafter: Holmatro) cannot be held liable in any way for the consequences of activities undertaken on the basis of this printed matter. Values can vary within the manufacturer measurements. If you have any doubts about the correctness or completeness of the information, you shall contact Holmatro (T +31 (0)162-751480). Nothing from this printed matter can be copied and/or made public in any way without the explicit authorisation of Holmatro.