

Technical specification sheet

12 S 12 G |

Specifications		
article number		101.003.029
model		12 S 12 G
max. working pressure	psi	10443
capacity oil tank (effective)	oz	405.8
number of outputs		1
number of stages		1
first stage output / min.	oz	37.2
first stage pressure range	psi	0 - 10443
operator type		electric motor
engine		110-120 VAC - 1.5 kW - 60 Hz - 1 Ph
speed	rpm	3600
weight, ready for use	lb	101.4
dimensions (AxBxC)	in	15.7 x 15.9 x 23.3

Technical drawing dimensions		
dimension A	in	15.7
dimension B	in	15.9
dimension C	in	23.3

Required Accessories		
Control Valve - Single Acting - M 311		100.181.311
Control Valve - Double Acting - M 322		100.181.322

Accessories		
Single-/Double Acting Valve (SADA) M 304		100.172.051
Control Valve - Double Acting - M 323 (Deadmans Function)		100.181.323
Remote Control Valve + Oil Filter - Double Acting - M 326		100.182.321
Pressure Control Valve M 303		100.181.303

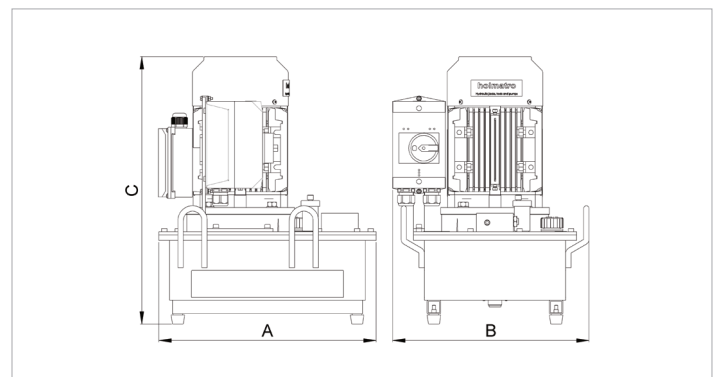

holmatro.com

© Holmatro 2025-09-28

While the greatest care has been devoted to the content, it is possible that the information in this printed matter is incorrect or incomplete. Holmatro B.V. and its affiliated companies (hereafter: Holmatro) cannot be held liable in any way for the consequences of activities undertaken on the basis of this printed matter. Values can vary within the manufacturer measurements. If you have any doubts about the correctness or completeness of the information, you shall contact Holmatro (T +31 (0)162-751480). Nothing from this printed matter can be copied and/or made public in any way without the explicit authorisation of Holmatro.