

Technical specification sheet

HFC 50 S 1.5 | Flat Cylinder

Specifications		
article number		100.112.296
short description		Flat Cylinder
model		HFC 50 S 1.5
max. working pressure	psi	10443
tonnage	lb	110231.0
stroke	in	0.6
closed height	in	2.8
capacity	lbf	114742
effective pressure area	sq. in.	11
required oil content (effective)	oz	3.6
connection		A 118
cylinder type		flat
acting type		single
return type		spring
material		steel
weight, ready for use	lb	15.4
ASME		B30.1

Technical drawing dimensions		
dimension A	in	2.8
dimension B	in	5.5
dimension B2	in	4.7
dimension C	in	3
dimension D	in	3
dimension E	in	0.7
dimension F	in	2.7
dimension U	in	2.6
dimension V	in	0.5
dimension W	in	2.1
angle A1	°	5

Standard supplied with	
• Standard provided with fixing holes for easy assembly	
• Dirt scraper ring	
- Protects against pollution	
- Increases the life span	
• Superior seal for an excellent static and dynamic sealing	
• Splined plunger, no saddle needed	
• High flow female coupler A118	

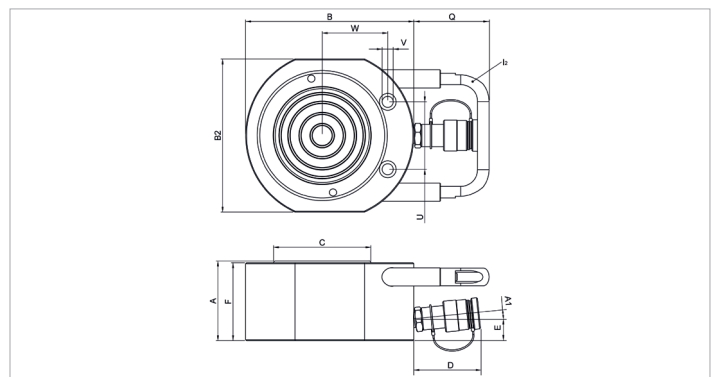

holmatro.com

© Holmatro 2025-10-01

While the greatest care has been devoted to the content, it is possible that the information in this printed matter is incorrect or incomplete. Holmatro B.V. and its affiliated companies (hereafter: Holmatro) cannot be held liable in any way for the consequences of activities undertaken on the basis of this printed matter. Values can vary within the manufacturer measurements. If you have any doubts about the correctness or completeness of the information, you shall contact Holmatro (T +31 (0)162-751480). Nothing from this printed matter can be copied and/or made public in any way without the explicit authorisation of Holmatro.