

Technical specification sheet

HGC 100 S 25 | Multi Purpose Cylinder

Specifications		
article number		100.112.260
short description		Multi Purpose Cylinder
model		HGC 100 S 25
max. working pressure	bar/Mpa	720 / 72
tonnage	t	100
stroke	mm	250
closed height	mm	418
capacity	kN/t	1031 / 105.1
effective pressure area	cm ²	143.1
required oil content (effective)	cc	3579
connection		A 118
cylinder type		multi purpose
acting type		single
return type		spring
material		steel
weight, ready for use	kg	64.1
ASME		B30.1

Technical drawing dimensions		
dimension A	mm	418
dimension B	mm	175
dimension C1	mm	117
dimension C2	mm	72
dimension D	mm	80
dimension E	mm	30
dimension F	mm	410
dimension G	mm	10
dimension J	threadsize	6 7/8"-12-UN
dimension K	mm	57
dimension L	mm	80
dimension M	mm	10
dimension N	mm	146
dimension O	threadsize	M12x24 (4x)
dimension T	mm	225
dimension U	mm	54
angle A1	°	45

Standard supplied with
<ul style="list-style-type: none"> • Collar thread and base mounting holes • Internal plunger thread on all models to 50 tons • High flow female coupler A118 • Flat saddle

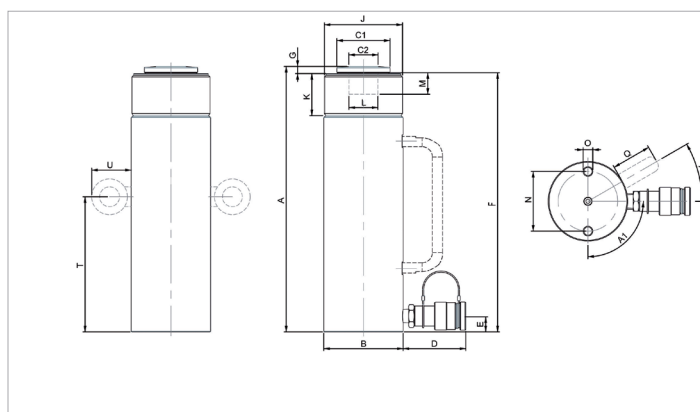

holmatro.com

© Holmatro 2025-09-30

While the greatest care has been devoted to the content, it is possible that the information in this printed matter is incorrect or incomplete. Holmatro B.V. and its affiliated companies (hereafter: Holmatro) cannot be held liable in any way for the consequences of activities undertaken on the basis of this printed matter. Values can vary within the manufacturer measurements. If you have any doubts about the correctness or completeness of the information, you shall contact Holmatro (T +31 (0)162-751480). Nothing from this printed matter can be copied and/or made public in any way without the explicit authorisation of Holmatro.